

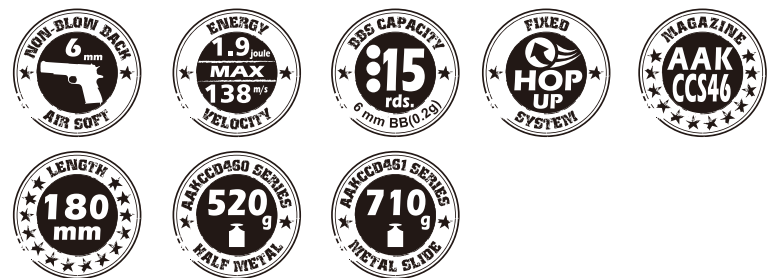

## AAKCCD46 系說明書

### AAKCCD46 INSTRUCTION MANUAL



**KWC** KIEN WELL TOY INDUSTRIAL CO., LTD  
SINCE 1978 [www.kwcgun.com](http://www.kwcgun.com)

台南市仁德區義林路168巷89號  
NO. 89, LN. 168, YILIN RD., RENDE DIST., TAINAN CITY 71752, TAIWAN (R.O.C)  
TEL: +886-6-2798175 FAX: +886-6-2798176 sales@kwcgun.com

## 操作說明 / OPERATION

### 射擊前的準備 BEFORE SHOOTING



- 按下卡榫  
Press the button.
- 取出彈匣  
Release the magazine.

- 使用六角板手反時針方向取出彈匣底內件。  
Use hexagonal wrench to remove the magazine cap by counter-clockwise.

- 逆時針轉出彈匣底內件後，置入小鋼瓶B，再以順時針方向鎖緊彈匣底內件A。當刺破鋼瓶出氣時，請快速鎖緊。  
Turn the magazine cap out counter-clockwise, and place CO2 cartridge B inside the magazine. Rapidly turn the screw A clockwise when piercing the cartridge in the magazine.

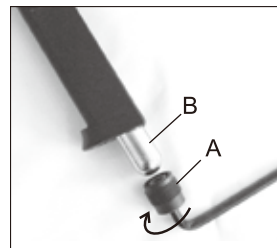

- 拉下滑粒。  
Pull the magazine follower down.
- 填裝B.B彈。  
Loading BBs.  
為了使擊發順暢，填裝方法是讓B.B彈在彈匣中一粒接著一粒。  
For smooth shooting, Load BBs one by one.
- 最多可裝15粒。  
Maximum BB capacity is 15 rounds.



### 射擊 SHOOTING

- 將裝好B.B彈的彈匣插入槍身往上推入，直到彈匣卡榫發出「卡嗒」聲為止。  
Insert fully loaded magazine in the airgun until you hear the sound of "CLICK".



2. 瞄準目標物扣引扳機，即可擊發。  
Aim the target and pull the trigger.



- ▲ 注意：在長期不使用的狀態下，請將彈匣內的氣體洩放掉。
- ▲ CAUTION: Release all of the gas in the magazine when it will not use in long-term period.

### 安全裝置 SAFETY

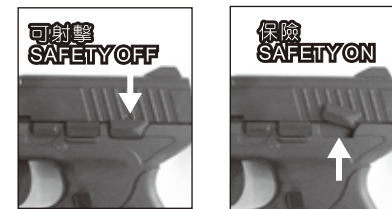

### 故障原因與排除 / BREAK DOWN FAQ

- 不良的B.B彈是造成卡彈的原因，請使用品質優良的B.B彈。  
Bad quality BB is the main reason to cause BB jam. Please use high quality BB avoid jamming problem.
- 當卡彈時，請儘可能先取出彈匣，再以不傷槍管的軟質細棒(不可大於6mm直徑)，從槍口置入清除。  
When BB jamming, first please release the magazine from pistol then use a soft stick (diameter no bigger than 6mm) to clear up the barrel.
- 空擊發易造成零件損耗，請避免此動作。  
Please avoid dry firing, for it could cause parts deformed or damage.
- 當扣引扳機時，此時B.B彈即同時在上膛階段，不可扣引一半時又回復，因為如此的動作，將有可能上膛兩發B.B彈。  
Pulling trigger will load BB in the barrel. Therefore, please do not pull the trigger half way and release the trigger. This action could load 2 BBs in the pistol and cause jamming.
- 使用一段時間後，請再次用含矽油之潤滑油，潤滑撞針及扳機軸心。  
Please spray lubricant(with silicone oil type) at firing pin and trigger pin after a certain of use, pictures shown.

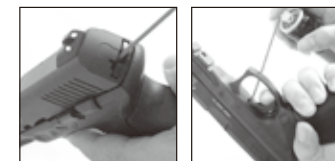

## WARNING 警告

請務必嚴格遵守使用說明指導書  
READ THIS OWNER'S MANUAL COMPLETELY

此低動能遊戲用槍是針對喜愛射擊運動的消費者所開發。避免因使用方法不正確或改造所發生的故障或事故，請務必詳讀說明書，正確的操作享受愉快的射擊運動。

- 除了發射時外，不要將手指頭掛在扳機上。
- 選擇安全與適當標靶。
- 在非使用期間，請保持保險關閉且退彈的狀態，就算在非使用狀態，也要如同其已裝彈。
- 如任何的機械產品，槍的保險也可能失效。即使在保險關閉的狀態下也請小心的操作此槍，請勿將槍口對人。
- 千萬不要對堅硬或平坦表面、水面射擊，以避免跳彈。
- 請妥善保管產品在未未成年孩童無法伸手取得的場所。
- 每次使用前後都應該檢查擋彈物，假如擋彈物表面有磨損失效或是反彈時請停止使用。
- 請使用高品質BB彈，請勿使用①口徑大於6mm②表面不平滑的③重複使用過的BB彈④非本說明書指名的發射物。
- 最高的使用及儲藏CO2小鋼瓶環境為50°C(122°F)以內，高溫可能會造成CO2小鋼瓶過熱甚至爆炸。
- 檢查任何掉落之槍枝，以確保未影響其功能。

**This airsoft is intended for recreational or training purposes. To prevent improper handling, modification or alteration causing malfunction or accident, please read the owner's manual carefully. Enjoy the pleasant shooting experience by proper operation.**

- Do not put your finger on the trigger except shooting.
- Please choose safe and proper target.
- Please always keep the airsoft on safe and unloaded when not using.
- Like all mechanical devices, an airsoft safety could fail. Always handle the airsoft safely even when the safety is "on safe". Never point the airsoft at any people.
- To avoid ricochet. Never shoot at a hard or flat surface or at water.
- Keep the airsoft out of reach for underage children.
- Your backstop should be inspected for worn out before and after each use. Discontinue use of the backstop if surface shows signs of failure or ricochet.
- Only use high quality BB. Never use ①BB diameter larger than 6 mm ②BB with unsmoothed surface ③reused BB that has been fired ④incorrect projectiles not design for this airsoft.
- Do not expose CO2 cartridges to heat or store them at temperatures above 50°C (122°F). CO2 cartridges may over heat or explode at temperatures above 50°C (122°F).
- Check any gun that has been dropped to ensure that its function has not been affected.

★使用低動能遊戲用槍前，請務必戴上保護眼鏡或面罩。  
★Always wear eye protection when using airsoft.

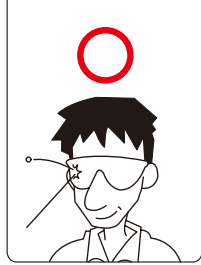

★攜帶低動能遊戲用槍在公共場所行走，請務必裝在袋子或盒子內。確認並未上膛和開啟保險。  
★When in public, always carry the airsoft in a locked carrying case or bag. Make sure it is unloaded and on safe.

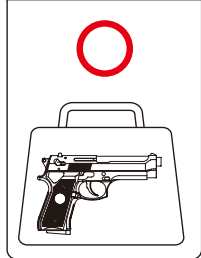

★使用低動能遊戲用槍前，請務必詳讀說明書內容。  
★Read the owner's manual before using the airsoft.

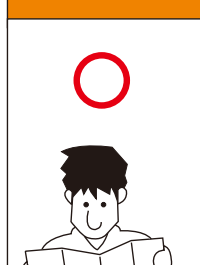

★請不要由槍口向內探視。  
★To Avoid accidental discharge, do not look directly into the barrel.



★請不要在公開場合使用低動能遊戲用槍，也請不要拿低動能遊戲用槍對準人或動物。  
★Never brandish or aiming this airsoft at any people or animals. Brandish this airsoft in public is dangerous and may be a crime.

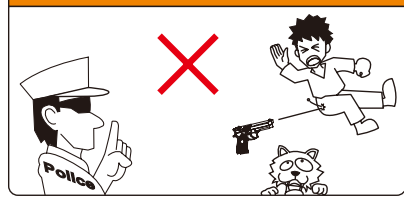

★請確認後再發射BB彈方向，附近無人或動物存在。  
★Always be aware of your surrounding before and during shooting and select a safe area for target practice.

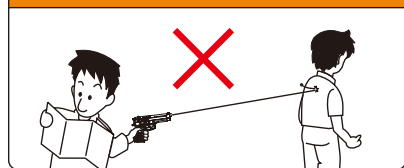

★不可任意改造或加工低動能遊戲用槍，私自改造加工會造成產品損壞、保固失效，導致使用上不安全，甚至觸法送辦。  
★Disassemble, modify, or alter of your airsoft may cause malfunction, revoke your warranty, make it unsafe to use and even break the law.

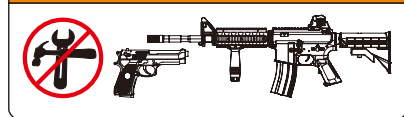

## KCCD46 系列 零件表 KCCD46 SERIES PARTS LIST

NO.	零件名稱	NO.	零件名稱	NO.	零件名稱
P31	心棒蓋迫緊	R01	子彈迫緊HOP-UP	S466	保險釋放件扭簧
P403	彈匣底內件			S613	彈匣卡榫線簧
P417	彈匣滑粒	B06-A	心棒	S804	撞針緩衝扭簧
P461	擊鐵箱(左)	B19	心棒蓋		
P462	擊鐵箱(右)	B33	氣瓶頂針	SM04	扳機連動件扭簧
P465	保險(左)	B215	氣瓶頂針迫緊	SM05	扳機連動件壓簧
P466	上蓋止動片	B461	槍管	SM63	撞針扭簧
P468	彈匣底座定位件	B468	撞針軸		
P469	導管配件			EA023	⊕2.3x8束黑 螺絲
P601	槍身本體	F03	軸(擊鐵)	EA061	⊕皿2.3x5束黑熱 螺絲
P602	槍身上蓋(ABS)	F401	心棒壓簧墊圈	ED008	E型扣環
P603	槍柄(射包)	F464	扳機連桿		
P607	彈匣卡榫	F465	扳機連桿壓簧軸	G001	O型環 φ0.8x φ11.3id
P727	槍管套	F468	保險釋放件	G004	O形環 1x3
		F601	軸(擊鐵箱用)	G005	O型環 1x4
Z442	撞針	F705	平頭軸(活塞卡榫用)	G006	O形環 1x5
Z462	槍身上蓋(Zn)			G009	O型環 1x7
Z465	扳機	S401	彈匣壓簧	G013	O形環 1.45x6.9id
Z466	彈匣	S404	心棒壓簧		
Z468	扳機連動件	S406	扳機扭簧	U1	內槍管組件
Z469	槍管連動件	S461	扳機連桿壓簧	U2	氣瓶頂針組件

零件有時為了改良而不經預告變更

## KCCD46 系列 零件表 KCCD46 SERIES PARTS LIST

NO.	UNIT	NO.	UNIT	NO.	UNIT
P31	VALVE PACKING	R01	RUBBER CHAMBE	S466	SAFETY RELEASE SPRING
P403	MAGAZINE BOTTOM CAP			S613	MAGAZINE CATCH SPRING
P417	MAGAZINE FOLLOWER	B06-A	VALVE	S804	FIRING PIN BUFFER SPRING
P461	CHASSIS(L)	B19	VALVE CAP		
P462	CHASSIS(R)	B33	PUNCTURE VALVE	SM04	TRIGGER CONNECTOR SPRING
P465	SAFETY(L)	B215	PUNCTURE VALVE PACKING	SM05	TRIGGER CONNECTOR SPRING
P466	SLIDE STOPPER	B461	INNER BARREL	SM63	FIRING PIN SPRING
P468	MAGAZINE BASE LOCATOR	B468	FIRING PIN AXLE		
P469	OUTER BARREL ACCESSORY			EA023	SCREW 2.3x8
P601	FRAME	F03	PIN (HAMMER)	EA061	SCREW 2.3x5
P602	SLIDE	F401	VALVE SPRING GASKET	ED008	E-RING
P603	GRIP	F464	TRIGGER BAR		
P607	MAGAZINE CATCH	F465	TRIGGER BAR SPRING PIN	G001	O-RING
P727	OUTER BARREL CAP	F468	SAFETY RELEASE	G004	O-RING 1x3
		F601	PIN (CHASSIS)	G005	O-RING 1x4
Z442	FIRING PIN	F705	PIN (PISTON CATCH)	G006	O-RING 1x5
Z462	SLIDE			G009	O-RING 1x7
Z465	TRIGGER	S401	MAGAZINE SPRING	G013	O-RING 1.45x6.9id
Z466	MAGAZINE	S404	VALVE SPRING		
Z468	TRIGGER CONNECTOR	S406	TRIGGER SPRING	U1	INNER BARREL UNIT
Z469	BARREL TOW	S461	TRIGGER BAR SPRING	U2	PUNCTURE VALVE UNIT

Spare parts may be modified for quality improvement and such modification may be without advance notice.

## KCCD46系列 零件分解圖 KCCD46 SERIES EXPLODED VIEW

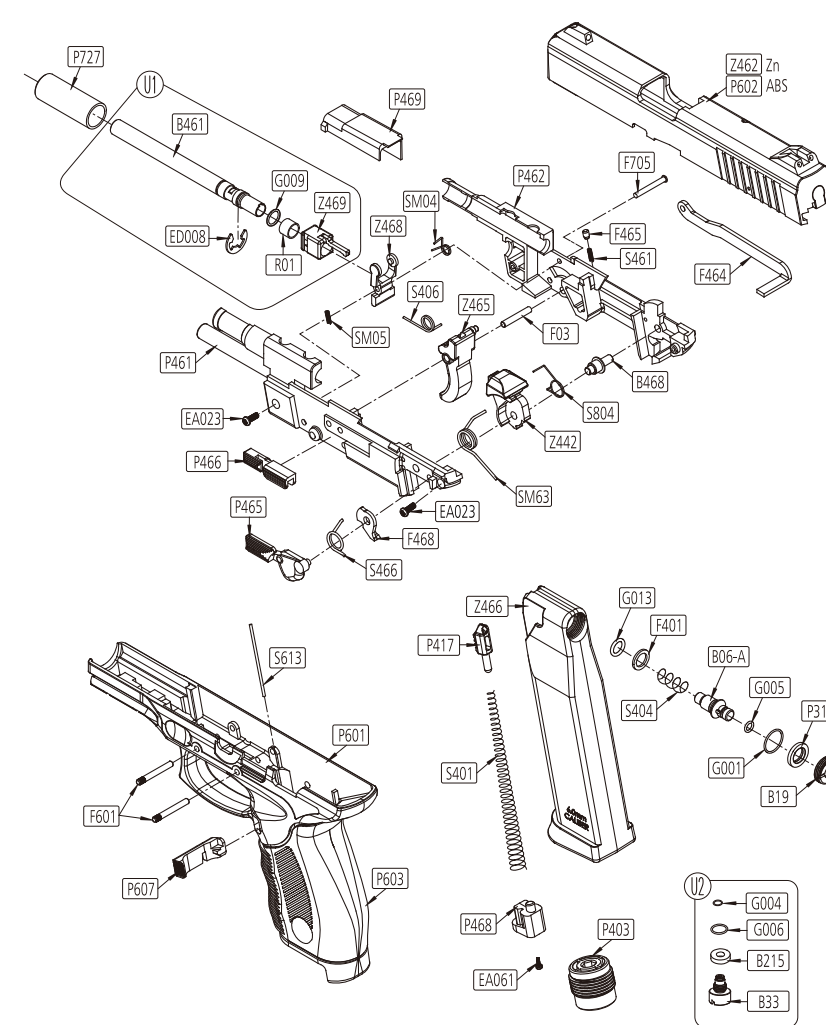

請不要忘了，雖然自己知道這只是玩具，但不知道的人會以為這是真槍。

Do not display this airsoft in public—it may confuse people and may be a crime.